

SUPPLEMENTAL INSTALL SHEET

Installation Sheet - Nissan Titan 2016+



IMPORTANT: READ FIRST



WITH the Utili-Track System Channel Installation

1 Slide the front half of the clamp into the rail in the tapered slot.

Position the rear clamp as close to the tailgate as possible. It should be less than 12".

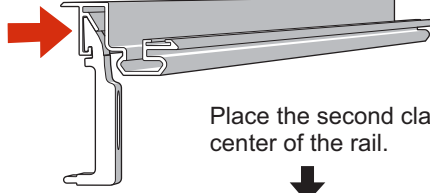

Place the second clamp near the center of the rail.

Position the clamp as close to the front of the rail as possible it should be less than 12" from the front

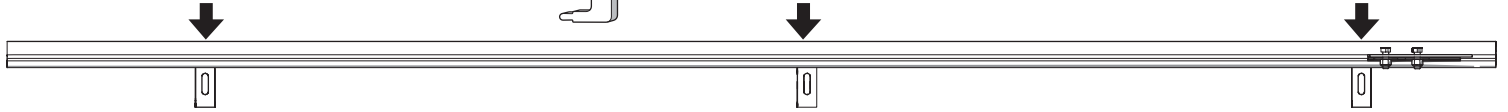

2 Slide the back half of the clamp directly into the vehicle tracks. The clamp halves install with the grooves facing out. Align the clamp as shown with the large grooved end first. **NOTE:** If reusing the factory tie-downs be sure to install them intermittently with the tonneau clamp halves.

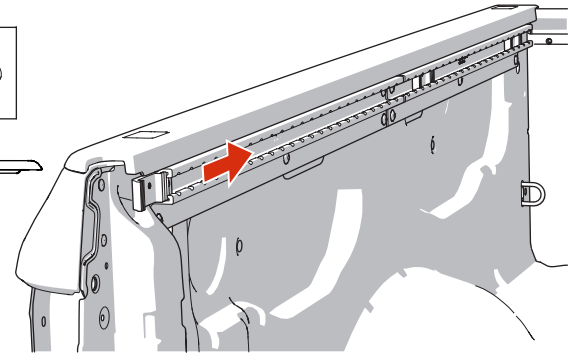
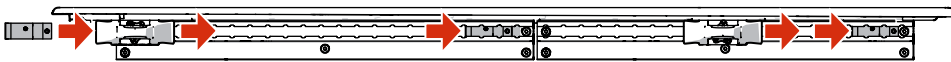
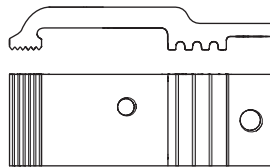

3 Place the rail onto the truck bed rail, match the two clamp halves and install the bolts and washers into each pair.

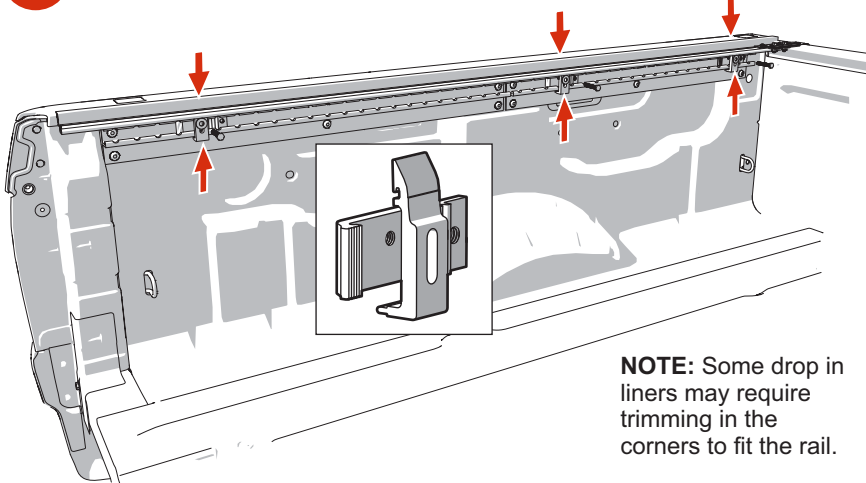

NOTE: Some drop in liners may require trimming in the corners to fit the rail.

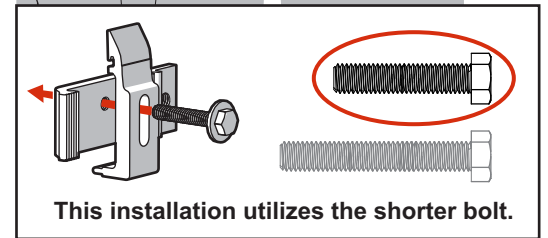
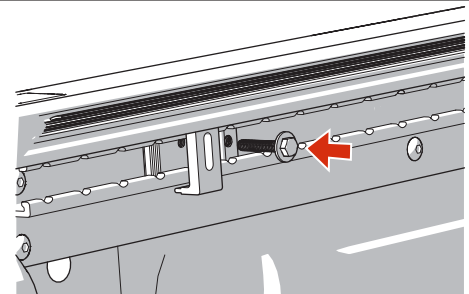

4 Tighten the bolts

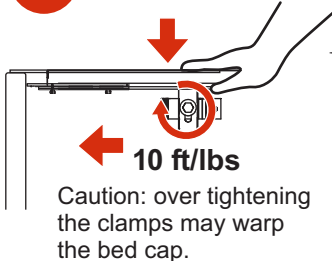

When tightening push down on the rails, as well as in towards the bed rail and forward toward the bulkhead.

The rails have shims in place to fill the difference made by the angle of the bed rail cover.

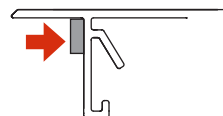

Return to Step 1 of the BAKFlip Installation Sheet

SUPPLEMENTAL INSTALL SHEET

Installation Sheet - Nissan Titan 2016+



IMPORTANT: READ FIRST



WITHOUT the Utili-Track System Channel Installation

- 1** Slide the front half of the clamp into the rail in the tapered slot.

Position the rear clamp as close to the tailgate as possible. It should be less than 12".

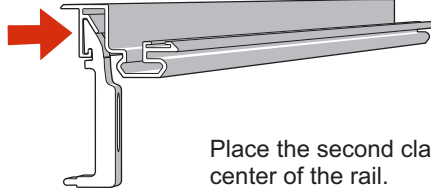

Place the second clamp near the center of the rail.

Position the clamp as close to the front of the rail as possible it should be less than 12" from the front

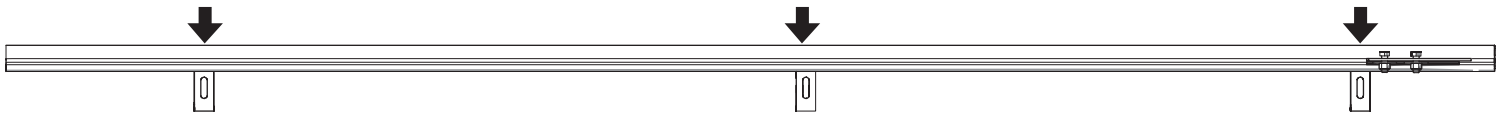

- 2** Place the rail on the truck and align an inside clamp half with each rail clamp half and with a bolt and washer.

- 3** Align a stepped spacer between the bed rail sheet metal and plastic liner.

NOTE: Some drop in liners may require trimming in the corners to fit the rail.

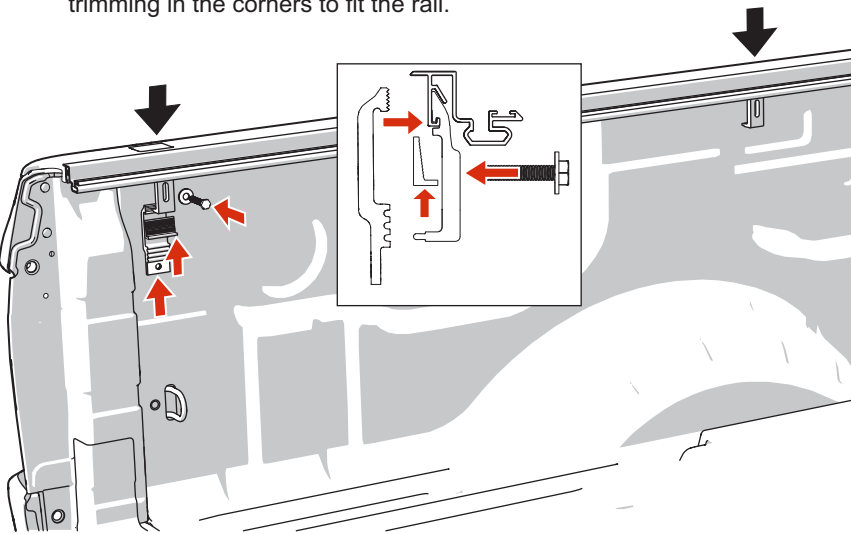

The stepped spacer is designed to fill the gap between the plastic liner and the metal rail flange.

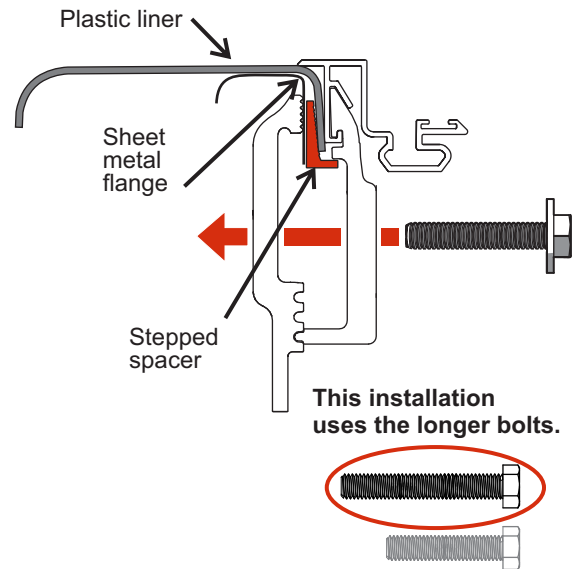

This installation uses the longer bolts.

- 4** Tighten the clamp bolts.

When tightening push down on the rails, as well as in towards the bed rail and forward toward the bulkhead.

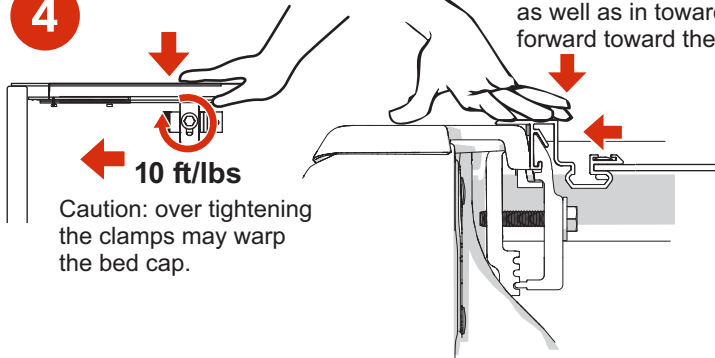

The rails have shims in place to fill the difference made by the angle of the bed rail cover.

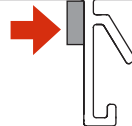

Return to Step 1 of the BAKFlip Installation Sheet